



Project RealTime

Report Of Activities Carried Out In 2001

01/08/2002

Funded by "Programa Dinamizador das Ciências e Tecnologias do Mar".

FCT (PDCTM1999MAR15287)

Table of contents

1	Introduction	3
2	Framework of The Project	3
2.1	Aim	3
2.2	Rationale	3
2.3	Objectives	4
2.4	Contribution to the objectives of " Programa Dinamizador das Ciências e Tecnologias do Mar"	4
2.5	WorkPlan	5
3	Project monitoring	5
3.1	Workpackage 1 – Modelling	5
3.1.1	Task 1.1 – Results	6
3.1.2	Task 1.2 – Results	11
3.1.3	Task 1.3 –Results	16
3.2	Workpackage 2 - Laboratory Work	18
3.2.1	Task 2.1 -Results	19
3.3	Work package 3 - Field Work and Data Management	23
3.3.1	Task 3.1 – Results	23
3.3.2	Task 3.2 – Results	36
3.4	Work Package 4: Integrated operational model	37
4	Summary of the first year of project	37
5	References	Error! Bookmark not defined.

1 Introduction

This report describes the activity developed during the first year of the project *REALTIME – Modelação e Aquisição de Dados em Tempo Real para Gestão Costeira* (PDCTM1999MAR15287) funded by the FCT.

The project is coordinated by IMAR- Instituto do Mar (Main researcher: Prof. Ramiro Neves) the partners are: Instituto Superior Técnico (IMAR), LNEC, Universidade Nova de Lisboa (IMAR), Hidromod and Instituto Hidrográfico. The project began at 1st January of 2001, with 3 years duration.

The project is “on schedule” having in mind that it is essential in a first stage to develop and test a robust data acquisition system that already shown good results and in parallel do implement and verify a model to explain the ecological and physical processes occurring in the Tagus estuary.

In the first part of this report we describe the framework of the project, afterwards we present the tasks already accomplished based on the work plan.

2 Framework of The Project

2.1 Aim

This projects aims to develop an integrated system of models, data acquisition and data banking to support management, monitoring and research in coastal areas.

2.2 Rationale

Ecosystem management is based on basic knowledge of its present conditions - data - and of the processes going on – experiments and models. Any management decision is taken having a model of the system in mind. The short-term decisions - e.g. those taken into emergency situations - are safer if supported by operational models (i.e models running in real time, as weather forecast models). Long-term planning has longer periods of study and can be based on other types of models. In any case interdisciplinary models considering as many state variables as possible are desirable.

Operational models must be validated using detailed time series (preferentially available in real time, in order to know the quality of the model results whenever they are need).

Data must be measured using sensors and transmitted to a database "quasi-continuously". Publication of model results in real time is also a stimulus for model improvement. The improvement of the models will be based on data measured and on process studies. Measured data publishing in real time is important for modelling but also because data is a managing tool by itself. The system must be accessed directly by the end-user and adequate interfaces and platforms must be implemented.

As a conclusion one can say that operational models can thus satisfy needs of managers with any time scale. Their implementation needs real time data acquisition systems and its implementation must be accompanied and followed by process-oriented studies to improve them continuously. The data acquisition system must be able to use the best sensors and thus the system can't depend on a unique manufacturer.

2.3 Objectives

Having the aims and their justification in mind the following objectives were defined for a 3 year period:

1. Adaptation of a modelling tool to be used operationally coupled to data acquisition systems,
2. Improvement of a WWW database to process and publish the acquired data and model results in real time,
3. Development of data acquisition systems to acquire and transmit data in real time,
4. Improvement of the model through process oriented studies,
5. Implementation and test of the system in a case study (in the Tejo estuary).

The state variables considered in field program are those relevant for management, measurable using sensors (velocity, water level, temperature, salinity, pH, O₂, nitrate, ammonia, chlorophyll, and suspended matter)

2.4 Contribution to the objectives of " Programa Dinamizador das Ciências e Tecnologias do Mar"

The program has integrating and interdisciplinary characteristics and aims to increase the national scientific capacity promoting structuring projects. This project integrates research teams from Universities (IST and FCTUNL), from Public Laboratories (INETI, LNEC and IH) and from a SME (Hidromod, Lda). The project will produce an integrated interdisciplinary tool to be used by the end-user (managers, technical staff and non-specialist scientists) after its terminus. Exploitation and updating of this product contribute for keeping the ties between these complementary teams.

2.5 WorkPlan

Workplan for project REALTIME., green represent the accomplished tasks during the first year and grey the task not yet accomplished.

Workpackages	Tasks	Partners				
		IST (IMAR)	Hidromod	IH	LNEC	UNL (IMAR)
1. Modelling	1.1 Flow and Water Properties Transport Modelling					
	1.2 Diagenetic and Ecological Modelling					
	1.3 Graphical Interfaces					
2. Laboratory Work	2.1 Settling velocity and consolidation rates					
	2.2 Critical shear velocities for erosion and deposition					
3. Field Work and Data Management	3.1 Field work and Data Acquisition					
	3.2 Data Banking and Publishing					
4. Integrated Operational Model	4.1 Integrated Operational Model					

3 Monitoring of Project execution

3.1 Workpackage 1 – Modelling

Tasks 1.1 and 1.2 can be divided in two stages, implementation and application. Implementation concerns the development of the algorithms to compute the processes that we wish to study including consistency tests and application concerns the application of these algorithms to the study area, in this case the Tagus estuary. The first stage is now finish, for the second stage, task 1.1, flow and water properties transport modeling is fully developed in the Tagus estuary and , task 1.2, diagenetic and ecological modeling is already under developement in the Tagus estuary but not finished.

3.1.1 Task 1.1 – Results

Several model grids are used in this study, according to the purpose. To study the hydrodynamics (transient circulation, residual circulation and residence time) the model uses a grid with a step varying between 3500 m at the open sea boundary and 300 m in the estuary. This grid has 196 by 166 points and covers a surface of 90 km by 76 km. Fig. 1 shows the whole model domain used for hydrodynamic simulations¹ and Fig. 2 shows a zoom of the Tagus estuary. Vertical and horizontal lines in Fig. 2 show the grid. To study the ecological processes, this bathymetry was integrated in space, merging 2x2 grid cells into one.

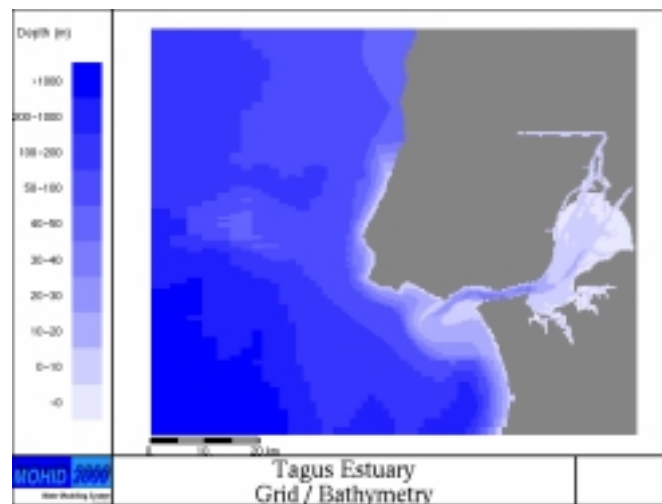

Fig. 1 Bathymetry of the Tagus estuary. The location of the Tagus River is deflected due for computational efficiency when only a subset of this domain is considered in the simulations.

¹ IN this bathymetry, the river is “turned left” to allow simulations with a subset of the domain, still preserving the size of the fresh water zone in the estuary.

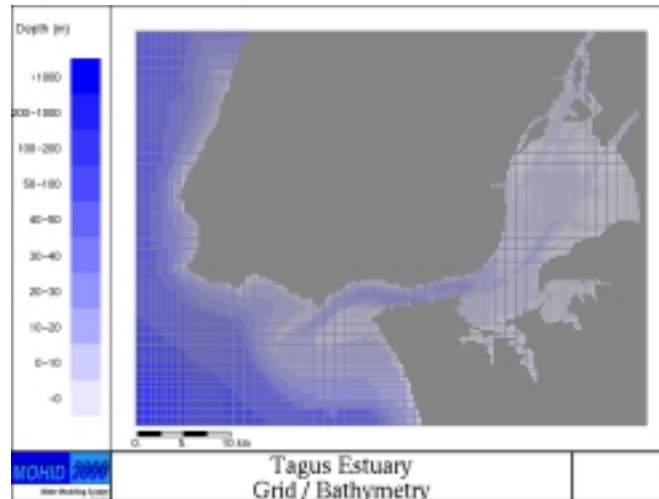

Fig. 2 Grid of the Tagus estuary model

3.1.1.1 Hydrodynamics

The Tide and the river discharge are the main forces driving the Tagus estuary hydrodynamics. In the present study tidal forcing was imposed at the open sea boundary using tidal harmonics obtained from a global tidal mode and River discharges were obtained from records. In some simulations the wind forcing was also considered, although its contribution for the flow is of secondary importance.

3.1.1.1.1 Transient circulation

To describe the transient circulation of the Tagus estuary, the model was run using the grid presented in Fig. 2 and forced with tide (all components) at the open boundary and with the average discharge of the Tagus River ($329.3\text{m}^3\text{s}^{-1}$). Simulations including both spring neap tidal conditions were accomplished and results are shown below for flood and ebb conditions. In all figures, colour represents the flow intensity and arrows the flow intensity and direction. Scales are indicated on the left side of the figures.

Fig. 3 and Fig. 4 represent the circulation during spring tide conditions. In these figures, it is possible to observe that inside the estuary, the water follows mainly the channels to reach the inter-tidal zones. Fig. 5 shows a zoom of the estuary mouth during ebb. In this figure, it is possible to see that the maximum velocity, in the channel connecting the main estuary with the open sea, reaches 2ms^{-1} . During neap tide periods, the flow intensity is obviously lower, with maximum velocities of about 1ms^{-1} .

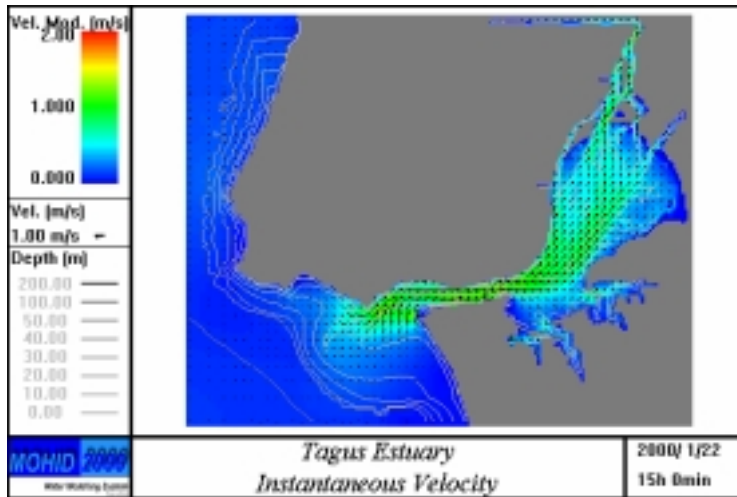

Fig. 3 Velocity field during a spring tide (flood).

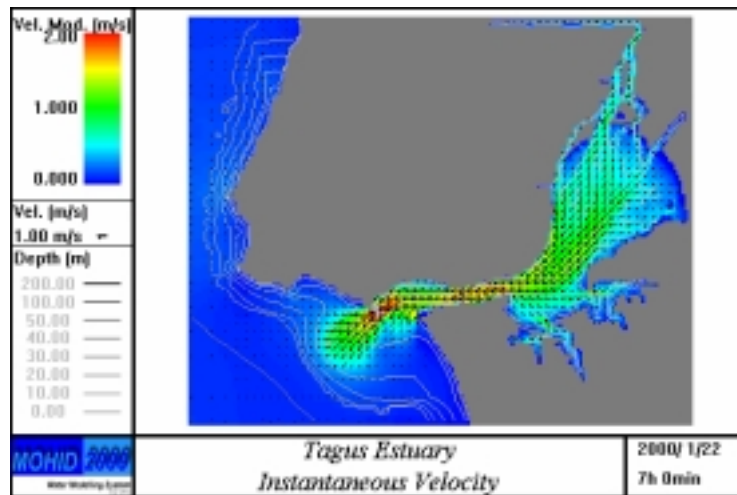

Fig. 4 Velocity field during a spring tide (ebb).

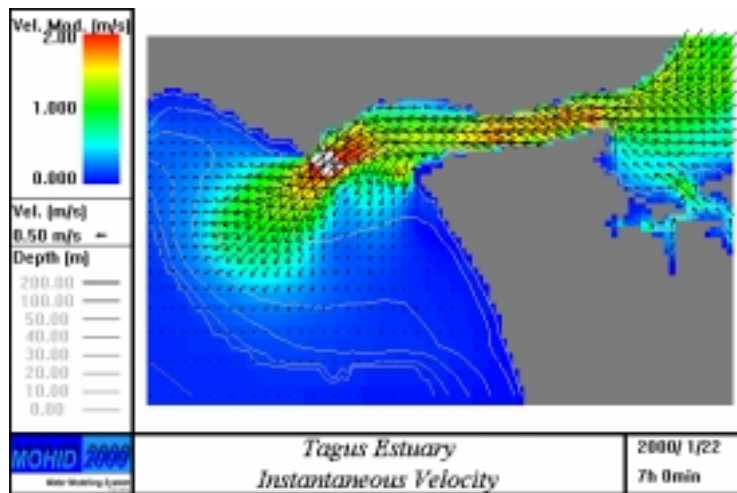

Fig. 5 Velocity field at the estuary mouth during spring tide (ebb).

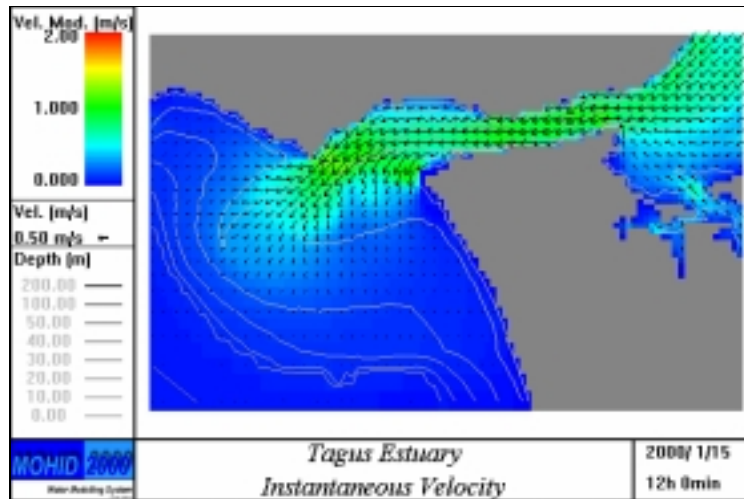

Fig. 6 Velocity field at the estuary mouth during neap tide (ebb).

3.1.1.1.2 Residual circulation

The transient circulation gives information about the instantaneous flow. For a better understanding of the transport processes inside an estuary, the residual circulation is also presented. The residual circulation is the average flow and gives an idea of the preferential transport of any property discharged in the estuary. To obtain the residual velocity, the model must run over a period of time much longer than the time periods associated to the variability of the transient flow. The results presented in this report were obtained integrating the transient flow during 30 days..

The residual circulation can be defined in several ways: (i) as the average of the transient velocity field (m/s), (ii) as average of the transient water flux per unit of length –residual specific flux (m^2/s) - or (iii) as the residual specific flux divided by the average depth of the water column – which is also a velocity - (m/s). The residual flux gives a picture of the residual movement of the water volume, but it is difficult to visualise in figures including both deep and shallow areas, because the adequate scale is a function of the depth. Residual velocity computed directly integrating transient velocity and, residual velocity derived from the residual flux are identical in deep areas, but can be very much different in shallow areas. The former is convenient to infer on sediment transport above the bottom, while the latter is more adequate to infer on the residual transport by the water column. Only the residual flux has null divergence.

Fig. 7 shows the residual velocity derived from residual flux at the mouth of the Tagus estuary. This figure shows two large eddies off the estuary mouth adjacent to the ebb

jet, with residual velocities that can reach 20 cm/s. These eddies determine the distribution of the properties close to the mouth, and show that seawater enters in the estuary mainly along the land boundaries. Strong eddies occupy the lower part of the estuary channel, creating preferential paths for the water entering and leaving the estuary.

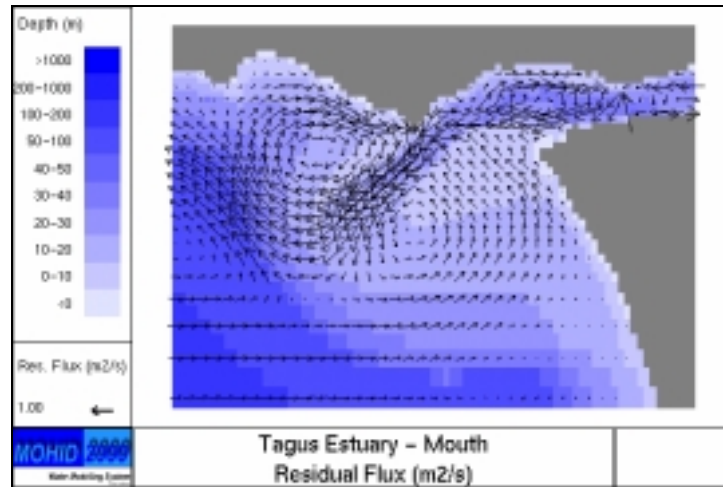

Fig. 7: Residual specific flux in the lower part of the Tagus estuary.

Fig. 8 represents the residuals in the interior of the Tagus estuary. Velocity is represented on the left and the specific flux on the right (only for the upper part of the estuary). In the upper part of the estuary the influence of the river discharge is very clear, showing the figure on the right side (specific residual flux) clearly the trajectory of the water. Most water flow along “Cala das Barcas” and a smaller part along “Cala do Norte”. In the Central estuary the flow is much more complex with small eddies, suggesting that this is an important mixing zone. In the lower part of the inner estuary there is a strong eddy which obliges material leaving the estuary to do it preferentially along the southern bank and water entering in the estuary to do it preferentially along the northern channel.

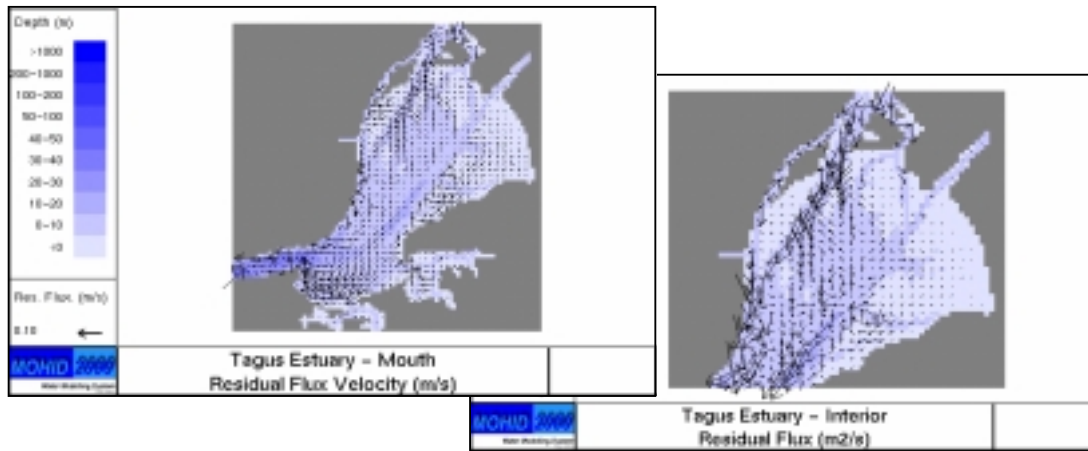

Fig. 8 Residual velocity in the Tagus estuary. On the left figure it is represented the residual velocity and on the right the residual specific flux.

3.1.2 Task 1.2 – Results

This section describes comparison of model results with field data records obtained in the 7 stations represented in Fig. 9. The analysis of the figures gives information on the trophic conditions of the estuary and on the capacity of the model to describe the functioning of the estuary.



Fig. 9 Location of sampling Stations used to evaluate the results of the model.

Five sampling stations are the most relevant for this project. “Station #1” is representative of the river water, and “Station #5”, of the ocean water. “Station #6” is the less interesting station because is measuring very close to the Trancão mouth, in a place where Trancão water is already diluted (and so does not represent its water), but in a place where concentration isn’t yet representative of the estuarine conditions in that region.

The set of figures below illustrate the field data records in 5 years, between 1994 and 1998. Records corresponding to the year of 1998 are represented by enlarged symbols since, as mentioned above, 1998 is the reference year in this project. This year was chosen to be the reference year because for this year there is a complete data set, including boundary conditions and monitoring data. The results of the model are represented by a discontinuous grey line representing instantaneous values. The range delimited by the discontinuous line shows tidal variability.

For each station there are four graphics corresponding to concentration of the four properties relevant for this study: Phytoplankton, Nitrate, Ammonia and Oxygen. Field data records are reported to high water and consequently they must be compared with the corresponding values of the model (lowest values of nitrate and phytoplankton and ammonia). The concentration of Oxygen depends on the tide, but also on the daily hour and no unique rule can be drawn for comparison.

From these figures one can extract information on: (i) absolute values, (ii), gradients (spatial variability), (iii) seasonal variability and (iv) model evaluation.

The figures show that inter-annual variability is of the same order of magnitude as seasonal variability. Horizontal variability is much more important than seasonal variability. At station #1 (close to the river entrance), nitrate varies between 1 and 2 mgN/L, between winter and summer. At the sea boundary (station #5), nitrate varies between 0.05 and 0.3 mgN/L. Comparing values at station #1 and #5, one can see that spatial variability is of about 1:20, bigger than seasonal variability. The same conclusion holds for the ammonia and for the phytoplankton.

Comparison between the model and field data has to be done in two steps. In a first step one must analyse stations close to the open boundaries (station #1 and #5) to evaluate the boundary conditions and in a second step, the station in the estuary.

At station #1 and #5 the comparison is quite good, showing that concentrations imposed at both boundaries are good, but also that the Tagus discharge is also good. Station #3 is the inner station in better conditions to be compared with the results of the model. Having in mind that the data must be compared with model results at high water (lower part of the curves of phytoplankton, ammonia and nitrate) one can see that results of the model and data compare very well. Station #7 is in Seixal channel, in a shallow area. All values computed by the model compare well with data, except for a few samples of

phytoplankton. This seems to be a consequence of the sampling time and of the grid used by the model. At high water this channel is flooded with downstream water poor in phytoplankton. The model grid is too coarse (600 meters) to represent correctly the flow in such a narrow channel and consequently tends to generate concentrations of phytoplankton much higher than those measured in high water. September and November samples compare very well with the model for different reasons. In November phytoplankton concentration is very low everywhere and consequently the problem of transport is irrelevant. In September, for any reason (e.g. detail of sampling time or wind effect) the surface water in the channel was already water from the shallow areas boarding the channel which are well represented in the model.

Station #6 is very much influenced by the Trancão, and tends to be less representative of a region of the estuary, especially if sampling time is such that water discharged by that river is sampled before mixing with estuarine water. That seems to be the case in August when very high values of ammonia and low values of oxygen were sampled. Another difficulty of this station to compare phytoplankton data with model results is the fact that the sampling point is located into a narrow channel with high transversal gradients during flooding, which are not well represented in the model. Anyway, the differences between phytoplankton measured in 1998 and model results are of the same order of magnitude as the inter-annual variability, showing that model results are representative of the estuary in that point.

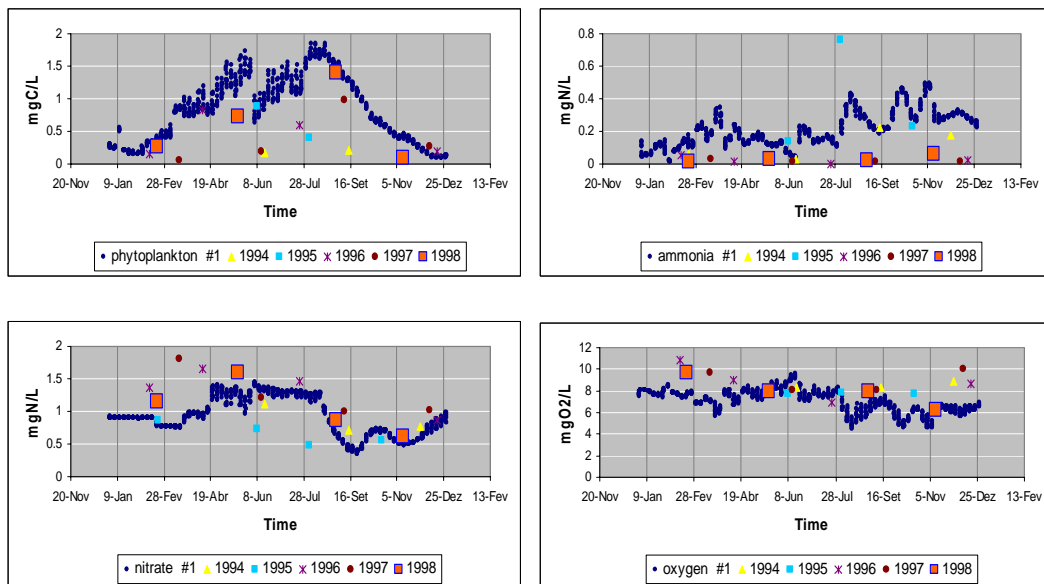

Fig. 10: Comparison of field and model results at Station #1.

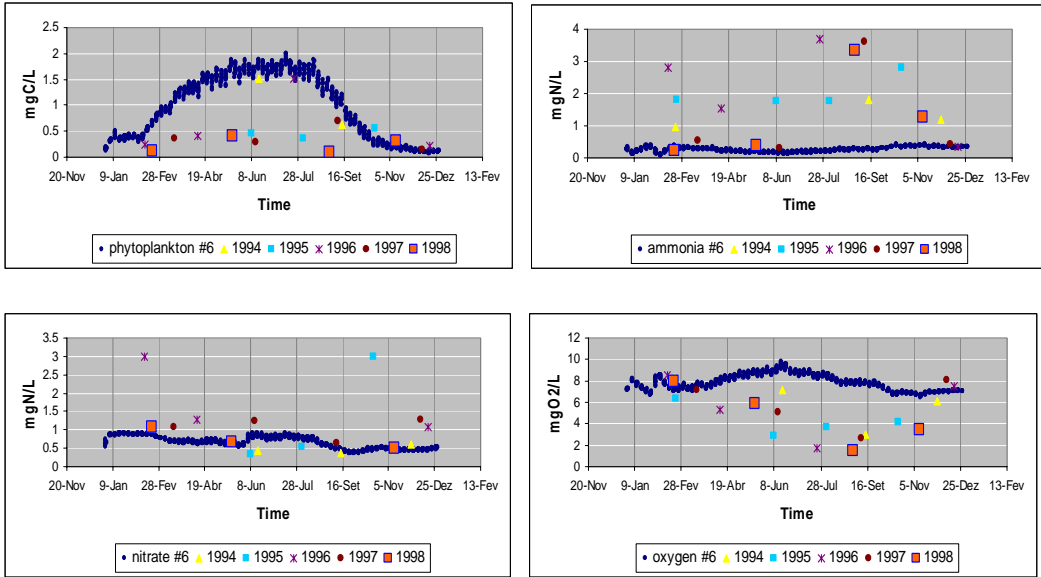

Fig. 11: Comparison of field and model results at Station #6.

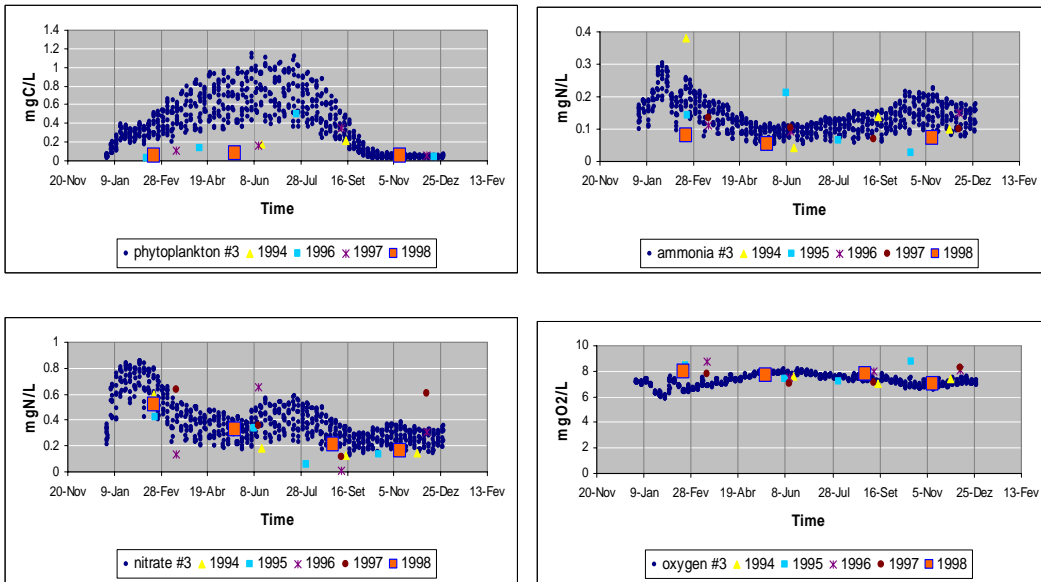

Fig. 12: Comparison of field and model results at Station #3.

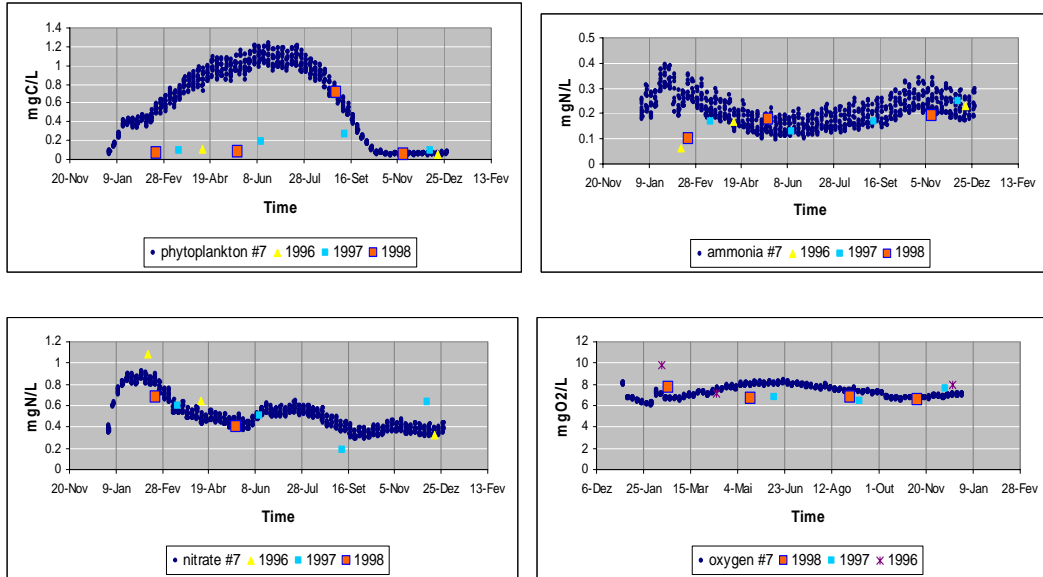

Fig. 13: Comparison of field and model results at Station #7.

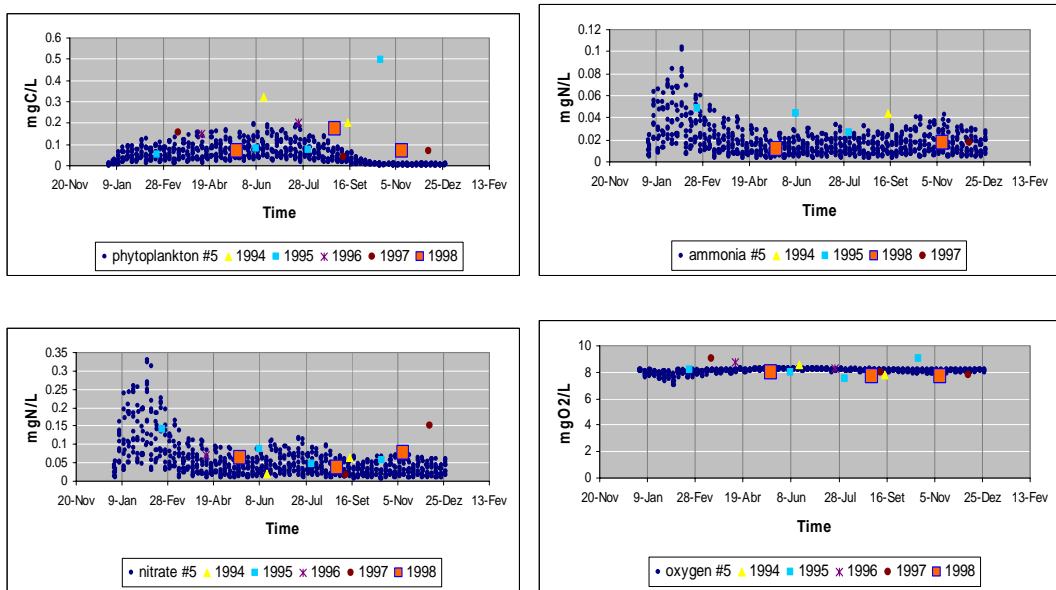

Fig. 14: Comparison of field and model results at Station #5.

3.1.3 Task 1.3 –Results

The Mohid Model has a graphical interface that allows the user to manage the input data of the model, execute the program and analyse the results. The graphical interface, *Mohid GUI* is written in FORTRAN code using the *MS Windows SDK (Software Development Kit)* to work in the Windows environment and the OpenGL libraries to visualise the results produced by the model Mohid.

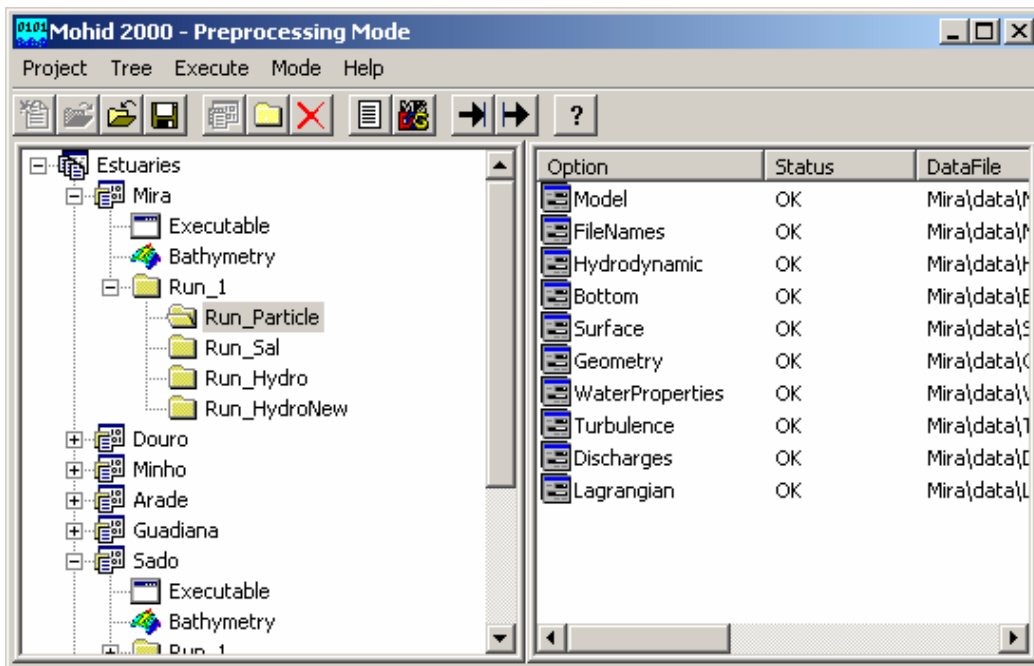

Fig. 15 Hierarchical management of the runs using the *Mohid GUI*

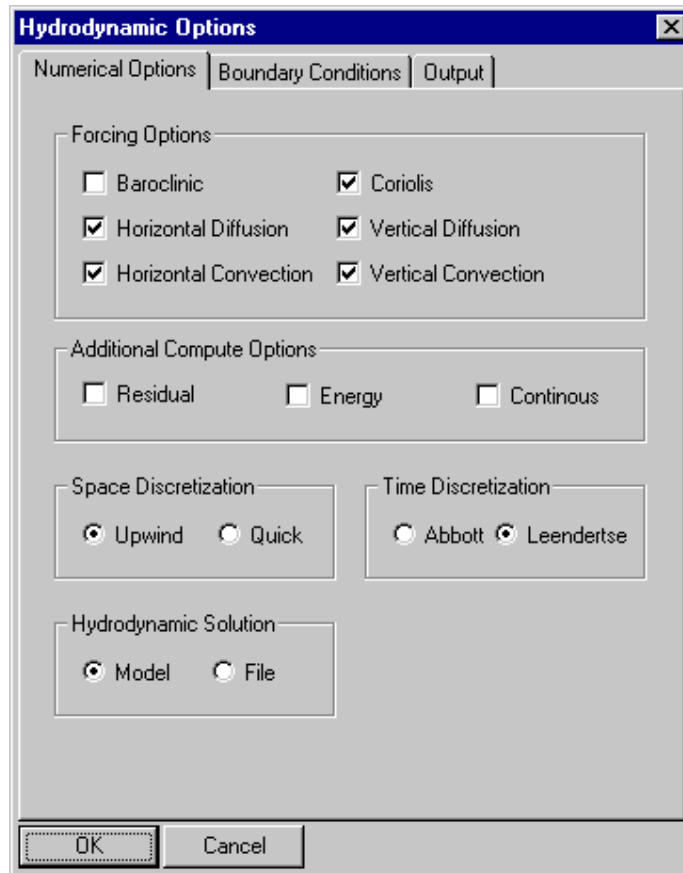

Fig. 16: Selecting the hydrodynamic conditions of the run

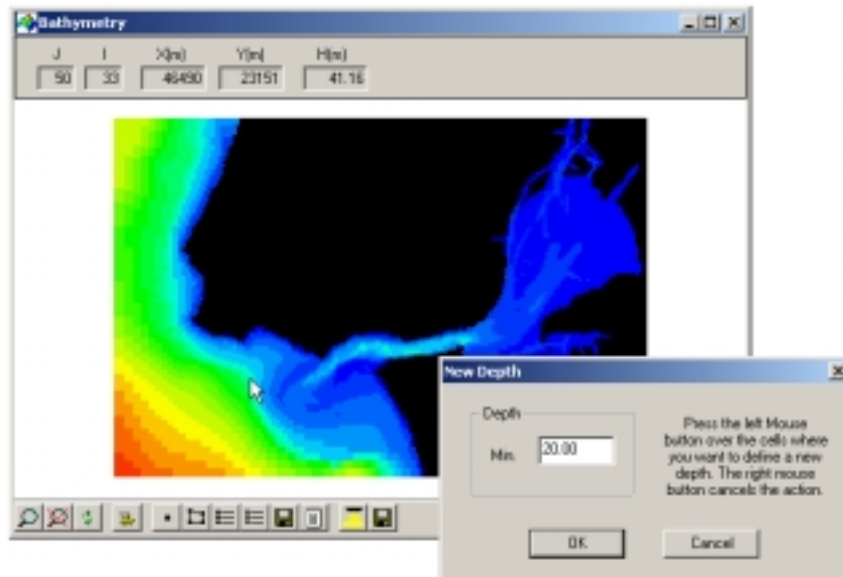

Fig. 17 Visualization of the bathymetry using the *Mohid GUI*

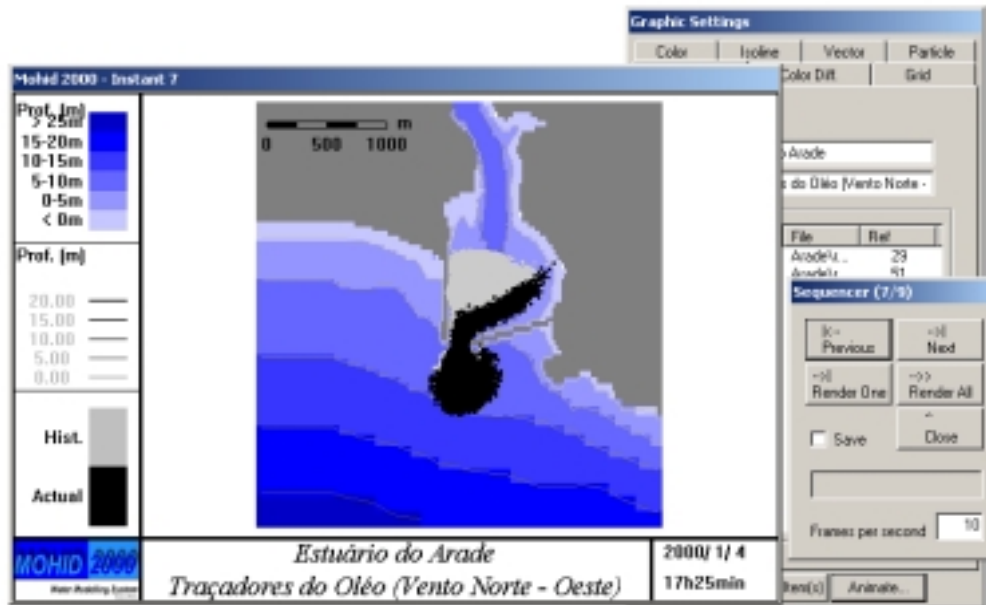
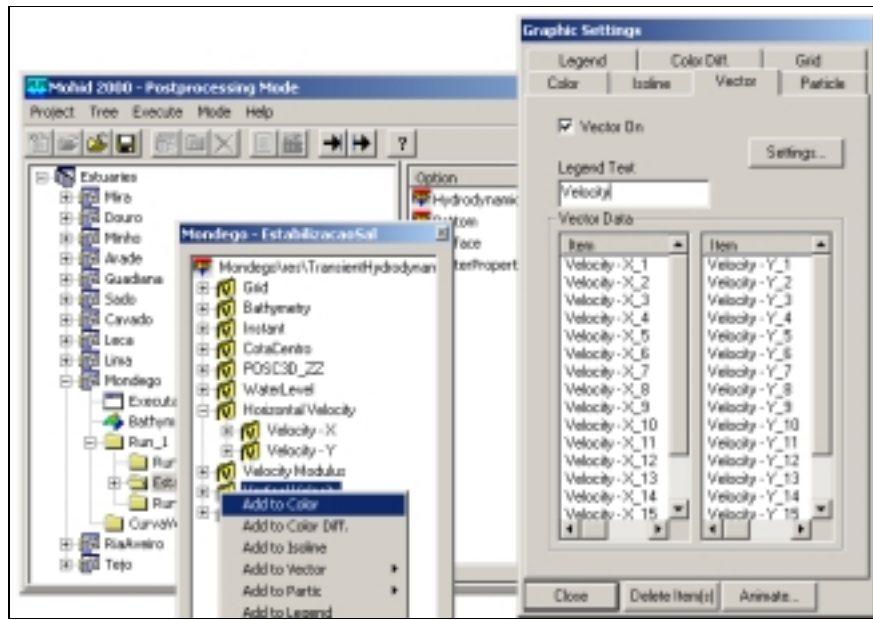

Fig. 18 Selecting the information to visualize

3.2 Workpackage 2 - Laboratory Work

The LNEC contribution consists in laboratory studies focussed on the transport processes of cohesive sediments. These studies are developed having the mathematical component in mind and considering the study area. Accordingly to original work plan, two major tasks were programmed:

- Task 2.1 Determining the sedimentation velocities of cohesive sediments, as a function of salinity, concentration and sediment constitution.

- Task 2.2 Determining the critical shear stress of deposition and erosion of cohesive sediment, considering their relation with sediment consolidation.

The activity developed in 2001, corresponds to the execution of the first task. We have programmed for 2002 the accomplishment of the second task, thus results will be available at the end of the second year of the project.

3.2.1 Task 2.1 -Results

3.2.1.1 Vertical velocity of cohesive sediments

The vertical velocity is an important parameter for modelling the transport and faith of cohesive sediments. The main objective of the essays done at LNEC was the study of the influence of salinity over the vertical velocity of cohesive sediments in the Tagus estuary. The obtained results were related with the concentration of suspended sediments and with the grain size distribution of the elementary particles

3.2.1.1.1 Methods

The sediments were sampled near Ponta da Erva (38°50,1'N; 8°57,9'W), in the Tagus estuary in 24 February 2001, at low water (Fig. 19 and Fig. 20). The grain size distribution of the superficial sediments collect at Ponta da Erva are presented in Fig. 21



Fig. 19 Image of the upper part of the estuary (Source: CNIG - Centro Nacional de Informação Geográfica).



Fig. 20 Sampling location: Ponta da Erva, Tagus estuary.

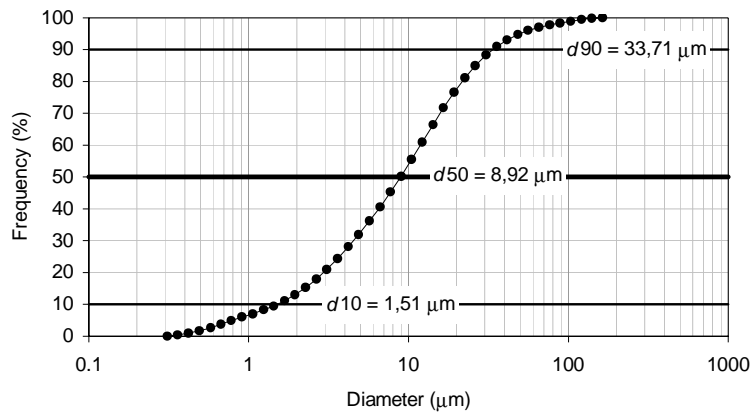

Fig. 21: Grain size distribution of the superficial sediment sample collect at Ponta da Erva in the Tagus estuary.

3.2.1.2 Results and Discussion

Fig. 22 shows the temporal evolution of the average concentration (average value of all levels) for each essay allowing an easy comparison between the salinity essays with 0, 2 and 15‰. In every essay, excluding the initial instants, it's easy to observe a gradual decrease of the average concentration with time. This decrease is more intense in the test with 15‰, confirming that in this case, a increase of sedimentation velocity is present caused by flocculation. The results for salinities of 0 e 2‰ are quite similar.

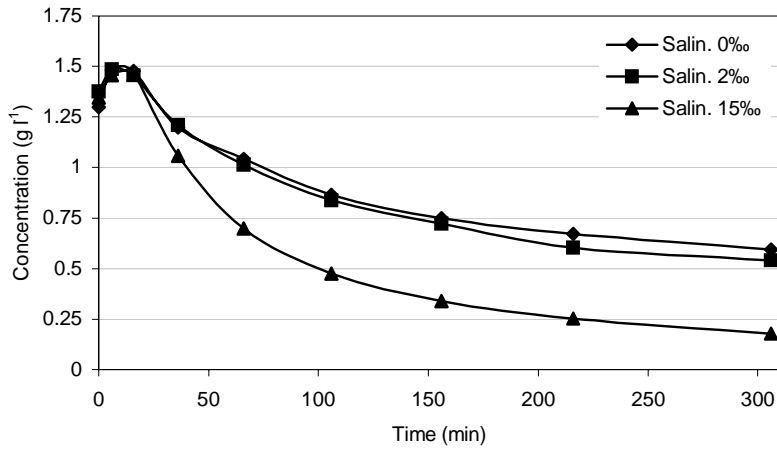

Fig. 22 Temporal evolution of the average concentration in tests with salinity 0, 2 and 15‰

The evolution of the average sedimentation velocity as a function of the concentration is represented in Fig. 23. Each test shows a reduction of the sedimentation velocity and a reduction of the concentration with time. It also shows that the average sedimentation velocity is similar in the test for 0 and 2‰ increasing significantly in the test with 15‰.

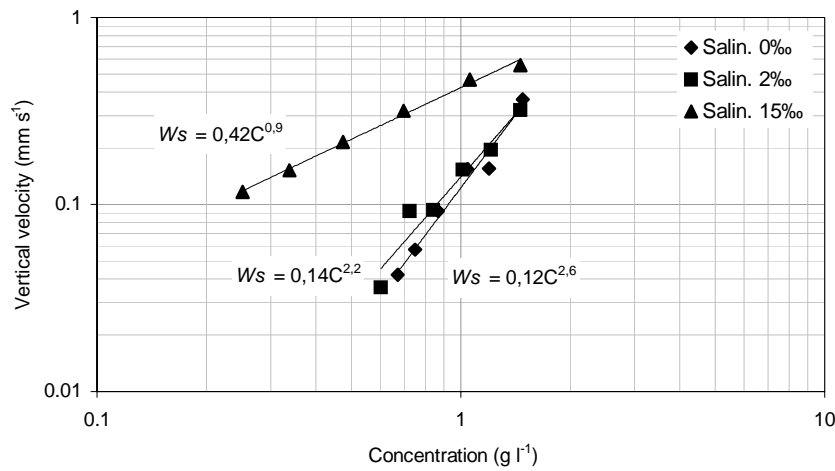

Fig. 23 Sedimentation velocity vs. Suspended sediment concentration considering the salinity values of 0, 2 and 15‰.

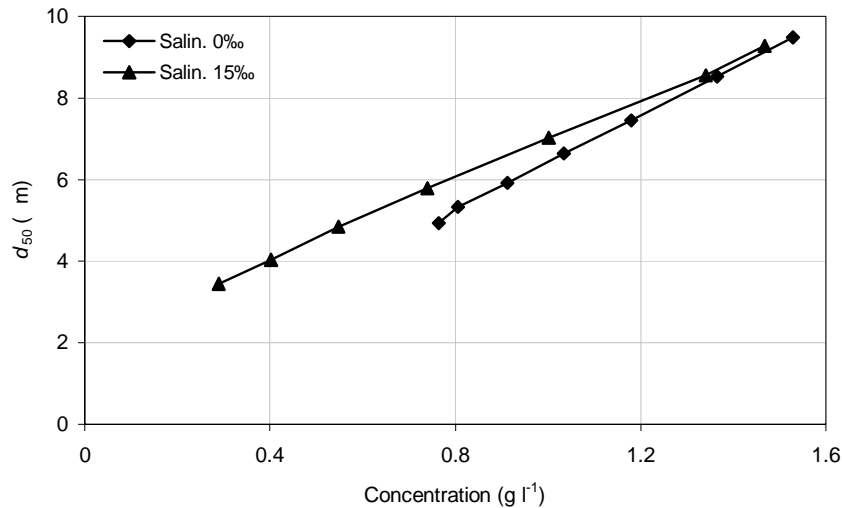

Fig. 24 Average diameter as a function of the suspend sediment concentration considering salinity values of 0 and 15‰.

The results of the grain size evolution, obtained in two specify tests wit salinities of de 0 e 15‰, are presented in Fig. 24.

Both tests show an average diameter reduction with time, suggesting that, the first step is the sedimentation of the large particles. With a salinity value of 15‰, the grain size reduction is faster, but a faster concentration reduction also takes place. The fact of the grain size doesn't reflect the flocculation caused by salinity (the average diameter in both test is similar) can be explained by the flocks destruction during sampling and analysis stages.

3.2.1.3 Task 2.1 Conclusions

The results obtained (for which the presented figures represented only a summary) are consistent with the results published for experiments with this kind of equipment (p.e. in what concerns the evolution of the concentration and sedimentation velocity; Rijn, 1993, p. 11.13). We can confirm that salinity influences the sedimentation velocity, which is usually observed in laboratory experiments. The fact that this effect is more pronounced for higher salinities (15‰) may be explained by the presence of organic matter, that will cause a inhibition of the flocculation process (Leusse, 1988).

The relation between sedimentation velocity and concentration is more apparent than real. The sediment used in the tests presents a non²-uniform grain size distribution, being most probable, that the larger particles show higher sedimentation velocities. These particles tend to sediment in the initial stage of the test, when the concentrations are higher.

This hypothesis seems to be confirmed by the grain size results, showing the distribution of elementary loose particles. Even in the test with higher salinity, when the flocculation is detected by the fast reduction of suspended sediment, it is still possible to detect a grain size reduction in particle with time. The results show that, in the case of cohesive sediments with a significant fraction of low cohesive silt, the grain size plays an important role determining sedimentation velocity.

3.3 Work package 3 - Field Work and Data Management

WP3 has a major importance in the framework of this project; this WP focuses on the data acquisition system, its construction and deployment. The success of the project depends mainly on the capability of this system to produce data and to establish an efficient way to spread it.

3.3.1 Task 3.1 – Results

The aim of this task is to install, test and operate two data acquisition buoys equipped with sensors to measure physical parameters, nitrate, turbidity and suspended matter. This task has been developed in two stages. In the first stage the system components were used as a mobile data acquisition system in different locations and on a second stage they were moored in navigation buoy giving real time results via GSM.

[1] ² LEUSSEN, W. van; 1988 – Aggregation of Particles, Settling Velocity of Mud Flocs: A Review. In: Dronkers, J. & Leussen, W. van (eds.) *Physical Processes in Estuaries*, pp. 347-403. Springer-Verlag, Berlin.

[2] RIJN, L.C. van; 1993 – *Principles of Sediment Transport in Rivers, Estuaries and Coastal Seas*. Aqua Publications, Amsterdam.

3.3.1.1 The data acquisition hardware of the mobile data acquisition system

The data acquisition hardware consists of a Campbell™ CR10X data logger with 8 differential analogous input ports and 64 k data points internal memory. The data logger is connected to a multiplexer allowing the acquisition of serial data from 4 different devices. To protect the system against transients and over voltages an opto-coupler provides galvanic isolation between the modem and the data logger. A Motorola Oncore 8 channel GPS receiver provides position fixes at the measurement site. A 6 Ah sealed lead acid battery assures enough power supply for at least 24 h continuous measuring. The whole electronic system is placed inside a rugged, waterproof Pelican™ plastic case. The case is equipped with external connectors for all attached devices, like antenna, computer and measurement instruments, which allows keeping the case closed during the field campaigns. A portable computer can be connected to the data acquisition system to graphically visualize the measurement data and store it on the computers hard disk.

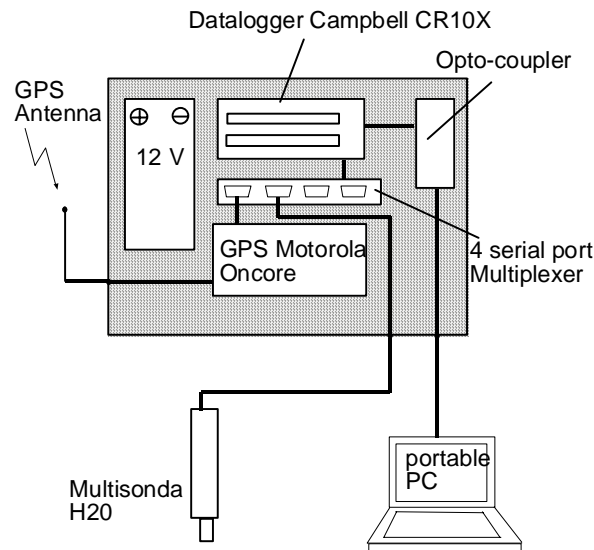

Fig. 25: - Boat operated mobile data acquisition system

3.3.1.2 The data acquisition software of the mobile data acquisition system

A custom made Visual Basic code is used to visualize the measurement data and store it to the computers hard disk. At a user defined interval the CR10X data logger sends one line of comma-separated data to the computers serial port. If in logging mode, the program permanently checks the serial port for new data. The program allows the user

to define the position of each parameter inside the data line. The user also defines whether a parameter is visualized or whether it is stored in the output file. A maximum of 255 different parameters can be defined and the whole set up is stored in a parameter file. The received data is then visualized as time series, and in addition the last value of each time record is visualized as number in a table.

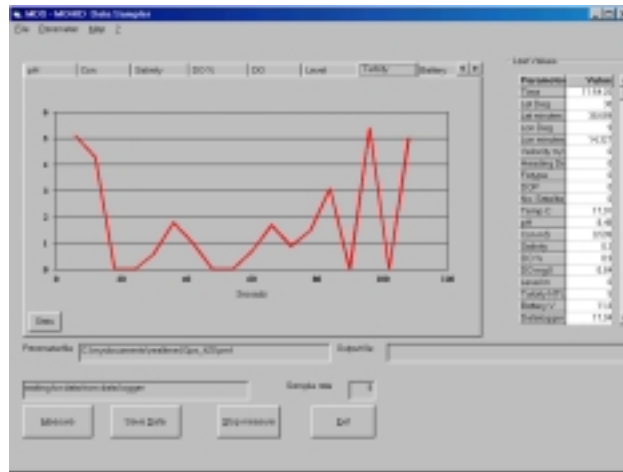

Fig. 26: - Graphical user interface for the mobile data acquisition system

3.3.1.3 Measurement results of the mobile data acquisition system

In 2001 the system was employed during several water quality field campaigns at the Estoril Coast and during measurements of the temperature plume in front of the Sines electrical power plant. The system proved itself to be a robust tool for field campaigns, even if used in small inflatable boats where water splashes inside the boat are common. In the performed field campaigns, the system was used to acquire vertical profiles of water properties. However, a flow pump shall be developed in the near future in order to sample horizontal profiles. Water samples can then be pumped in a continuously way into the boat where they are analyzed without risks to the sensors.

Fig. 27 shows some results obtained with the Hydrolab H20 Multi sonde attached to the data acquisition system.

Carcavelos Este

Latitude: 38°40,44'

Longitude: 9°19,82'

3 de Setembro 2001

BM: 9:40

PM: 15:56

BM: 22:03

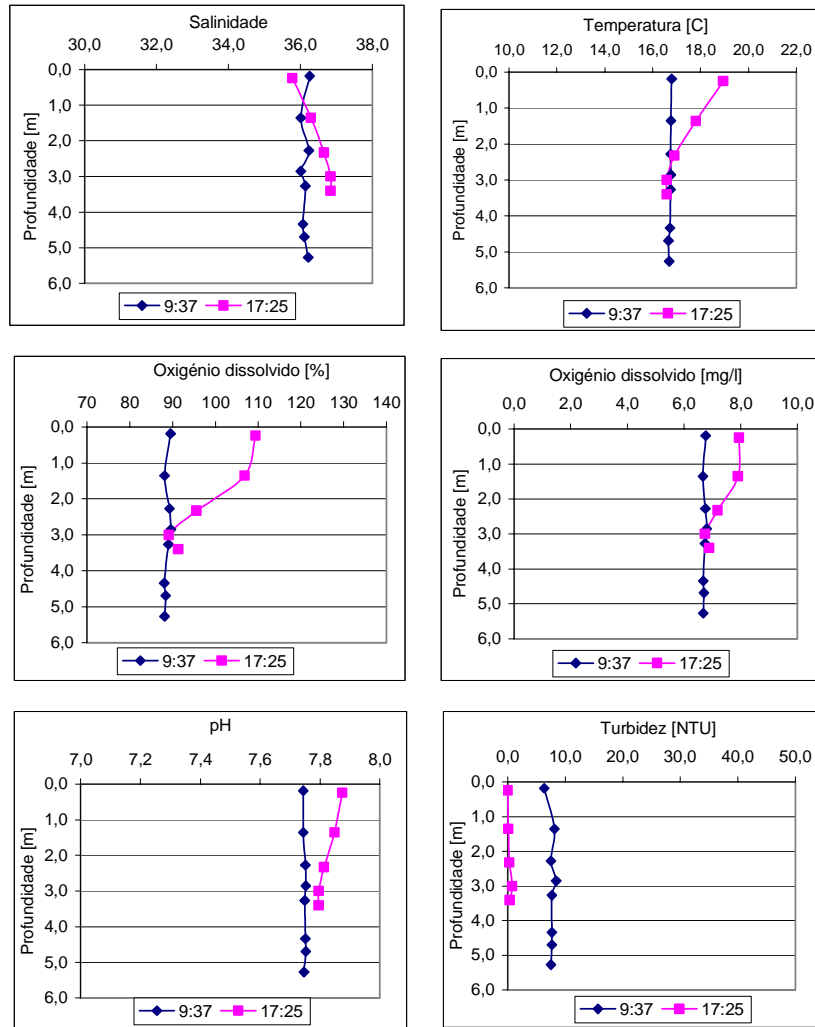

Fig. 27: - Physical-chemical parameters obtained during a field campaign at the Estoril coast

3.3.1.4 System Components using the real time data acquisition positioned in a Navigation Buoy

3.3.1.4.1 The data acquisition hardware

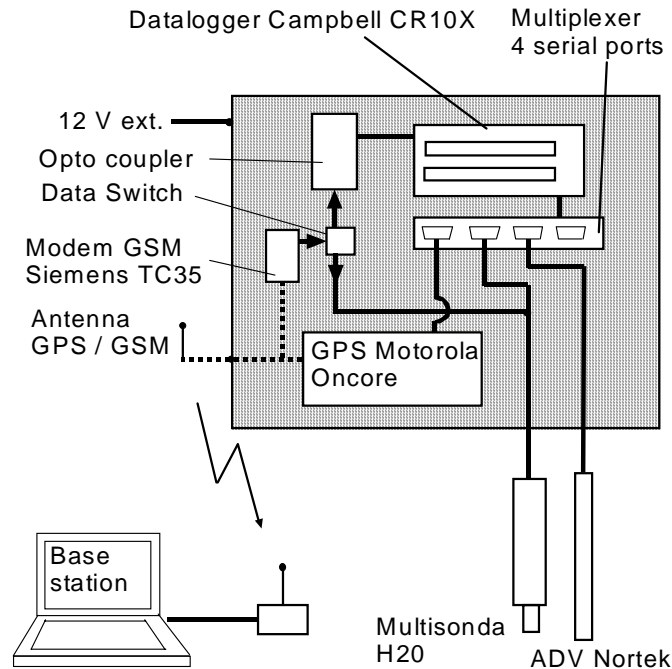

Fig. 28: Components of the data acquisition system

Similar to the system described in Part 1, the hardware consists of a Campbell™ CR10X data logger with 8 differential analog input ports and 64 k data points internal memory. The datalogger is connected to a multiplexer allowing the acquisition of serial data from 4 different devices. The data transmission between the remote and the base station is realized via two GSM modems (Siemens™ TC35), allowing a maximum data throughput of 14,4 Kb/s. To protect the system against transients and over voltages an opto-coupler provides galvanic isolation between the modem and the data logger. An additional user controllable data switch allows connecting the modem directly to the Multi parameter sonde. In this way an *in situ* calibration of the Multiparameter sonde can be performed, using a second sonde operated from a boat in vicinity of the buoy. The whole electronic system is housed in a waterproof stainless

steel well. Impulse™ underwater connectors were used for all connections outside the well even if they are not supposed to be submersed, following a full underwater design philosophy. The electronic well is inserted into a rack in a closed compartment inside the tower of the buoy, from where it can be easily detached for maintenance or repair, but where it is also safe against vandalism.

A Magnatec™ PCB 110 combined GPS /GSM antenna, mounted at the top of the buoy's tower, is used for data transmission and reception of the GPS position signals.

3.3.1.4.2 The Sensor package

The system measures a set of variables chosen to monitor the trophic activity in the estuary or a coastal region.

Currents are measured with a Nortek Aquadopp acoustic current meter, equipped with additional sensors for pressure, temperature, tilt and heading (compass).

The Multiparameter sonde (Hydrolab H20) is equipped with sensors for pressure, temperature, salinity, dissolved oxygen, pH and turbidity. The Motorola Oncore 8 channel GPS is mainly thought as security device to recover the buoy after an eventual mooring failure during a storm event. It provides a position accuracy of 30 m with Selective Availability (SA) turned off. The sensor package will be extended by a Fluorimeter for *Chlorophyll A* measurements, as well as with a Nutrient Analyzer for Nitrate concentrations. Furthermore a meteorological standard sensor package, including wind speed and direction, air temperature, air pressure and solar radiation is planned for the near future (Table 1).

Sensor (or group of sensors)	Manufacturer
CTD, O ₂ , pH, Turbidity, Pressure	Hydrolab
GPS	Motorola
Current Meter	Nortek Aquadopp ADV
Fluorimeter	Chelsea (ordered)

Nutrient Analyser	WS Ocean (ordered)
Air Temperature	To be acquired later
Atmospheric Pressure	idem
Anemometer	idem
Solar radiation	idem

Table 1: - Components of the sensor package

3.3.1.4.3 The Power System

The whole sensor package and the data transmission system is powered by two 10-Watt polymorph solar panels which are mounted to the buoy's tower. The panels are mounted at 180° to each other, and at 60° to the water surface. The two panels are switched in parallel and charge one 40 Ah sealed Lead Acid Gel Battery through a Morning Star™ regulator. The regulator is necessary to prevent overcharging of the gel cell batteries, which then can release explosive hydrogen gas. However, the battery was not mounted inside the sealed electronic well, but in the closed and well-vented lower part of the buoy's tower. Two blocking diodes prevent undesired current drain from one solar panel to the other (Fig. 29). The system was tested in clear sky during midday with the sun aligned with one solar panel, charging 0,6 amps into the battery.

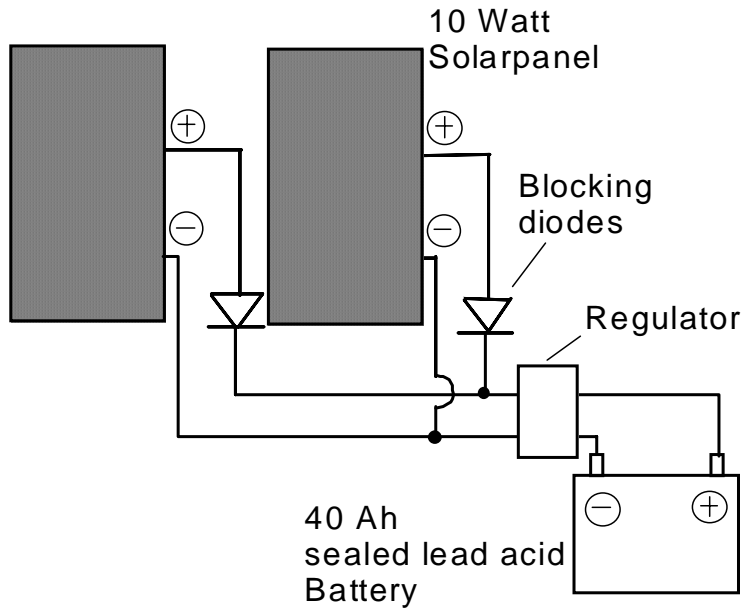

Fig. 29: - Power System

State	Measured Current drain [mA]	Duty cycle [Sec / hour]	Daily power Consumption [Ah/day]
Quiescent	180	3210	3,852
Measuring (H20, ADV)	380	60	0,152
Transmitting	450	30	0,09
GPS on	350	300	0,7
Total			4,794

Table 2: power consumption

Table 2 shows the current drain measured during different function modes. Due to its high current drain, the power of the GPS receiver is switched on just once every hour

during 5 minutes, using a relay circuit controlled by one of the data logger's control ports.

With the Multi sonde and the Current meter active during 10 s at a 10-minute sampling interval, and assuming furthermore a 1-hour GPS positioning cycle and a transmission interval of 2 hours the energy consumption yields about 4,8 Ah per day. Together with an estimated daily charge of 10 Ah from the solar panels, a security factor of over 2 is achieved. In case of complete failure of the solar panels, the system would have autonomy for about 8 days.

For security reasons, the buoy's signalization and navigation aid system is powered by a second, independent power supply system.

3.3.1.4.4 The Buoy

The system is installed on a MobilisTM Jet 2500 buoy provided by the Portuguese National Lighthouse Authorities, "Direcção de Faróis", and will be moored at the outer limit of the Tagus estuary at 38° 40,6' N and 9° 16,6' W (Fig. 30). The depth at the site is approximately 30 m. The buoy is part of the navigation aid system for the entry to the Lisbon Harbor. Substantial savings in time and costs concerning buoy, mooring, transport to site, signalization and the legalization process could be achieved by using an already existing buoy.



Fig. 30: - Mooring site at 38° 40,6' N and 9° 16,6' W

The buoy is made from galvanized steel and measures 6,30 m in overall height. A 1,85 m diameter polyethylene, floating collar, provides buoyancy. The tower contains a lockable compartment, with enough space for the batteries (Measurement and signalization) and the electronic well. A 30 mm diameter and 90 m length mooring chain is attached to the base of buoy.



Fig. 31: - Mobilis™ Jet 2500 Buoy³

3.3.1.4.5 The data acquisition software

A custom made Visual Basic™ code is used to perform the data transfer between the base station and one or more remote stations. All parameters relative to the data communication equipment are set within the program.

At a user defined interval the program establishes a connection between the two modems using standard AT commands. Following the data logger's communication protocol, binary data is then dumped to the base station where it is visualized as time

³ The picture shows a Mobilis Jet 2500, used in the Irish Integrated Coastal Analysis and Monitoring System (ICAMS)

series. After each data dump, a pointer in the data loggers memory is set, to distinguish between old and new data. The downloaded DATA is also stored in ASCII files, which later are imported in to the database.

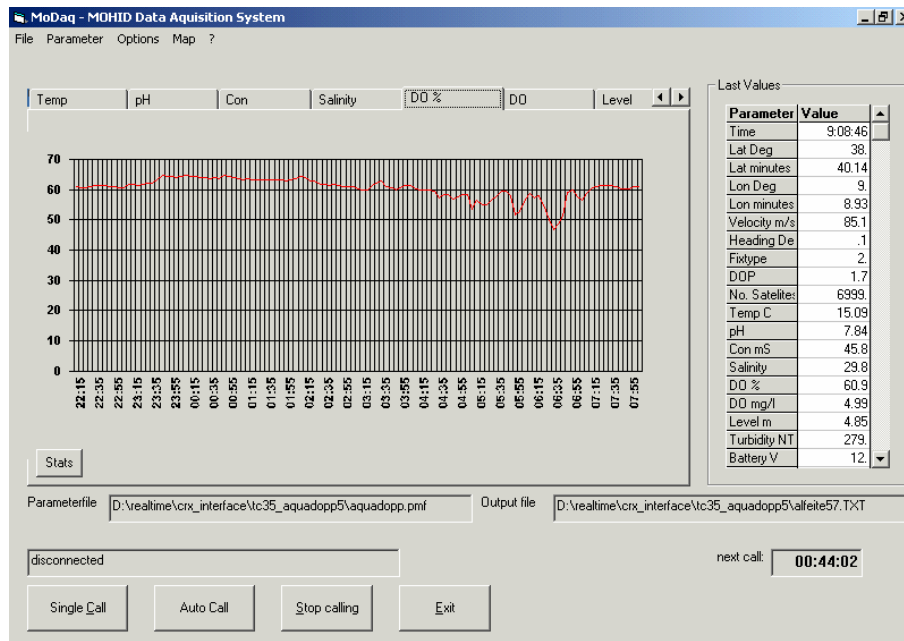

Fig. 32: - The Data acquisition software

3.3.1.5 System Testing using the real time data acquisition positioned in a Navigation Buoy

Tests were performed with the sensor package moored next to the pier of the Portuguese Naval Base in Alfeite, on the southern margin of the Tagus estuary. The tests started on the 14th of March and were still ongoing at the time of this report. The tests aimed to gather information about the system's behavior concerning, energy consumption, sensor fouling and system functionality in general. During the test phase, the system was already powered by the two 10-Watt solar panels, which will be mounted on the buoy. In spite of a quite rainy period in the beginning of the test phase, no voltage drop was observed at the battery. High algae concentrations, which should give a good idea about the maintenance and calibration intervals expected for the future, characterized the water at the test site. Fig. 33 shows a 3-day time record from the beginning of the test phase. This figure shows that the system is reliable and puts into evidence very interesting aspects of the flow (e.g. systematic "anomalies" of the temperature, salinity and turbidity).

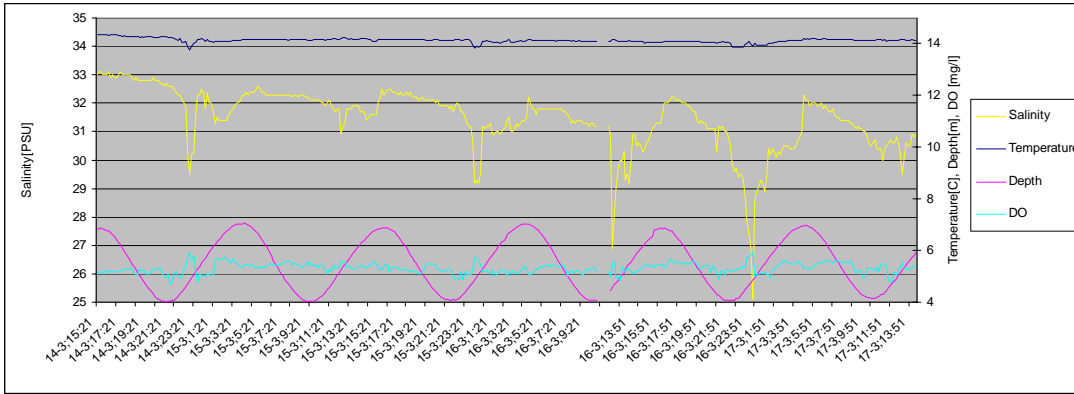

Fig. 33: - Temperature, Depth, Salinity, DO; 14th of March to 17th of March

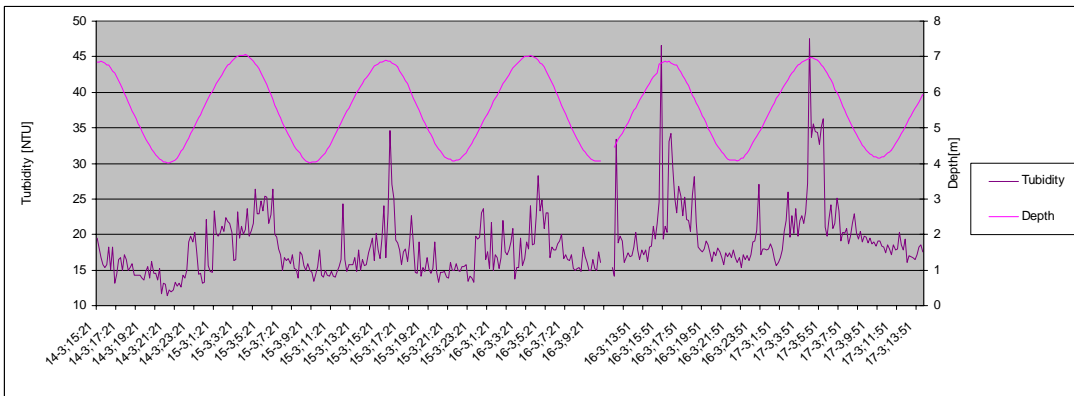

Fig. 34: - Turbidity, Depth; 14th of March to 17th of March

Fig. 35 shows a time record measured between 6th and 10th of April. Compared with Fig. 33, the Dissolved Oxygen readings sunk from slightly over 5 mg/l to slightly under 5 mg/l.

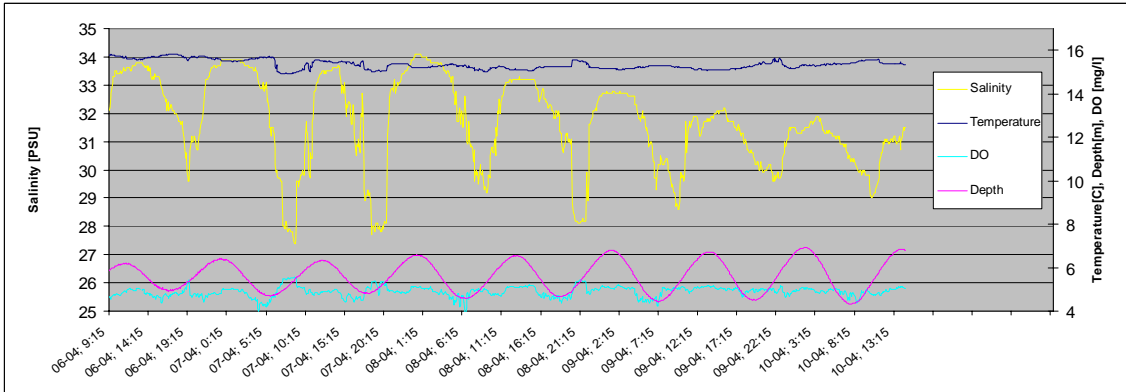

Fig. 35: - Temperature, Depth, Salinity, DO; 6th of April to 10th of April

Also, comparing Fig. 34 with Fig. 36 a drift in the turbidity readings becomes evident. Both sensor will have to be examined after recovering of the sensor package. The other sensors did not show any significant long-term drift. For the future, the use of a stirrer will have to be considered, in order to minimize fouling effects.

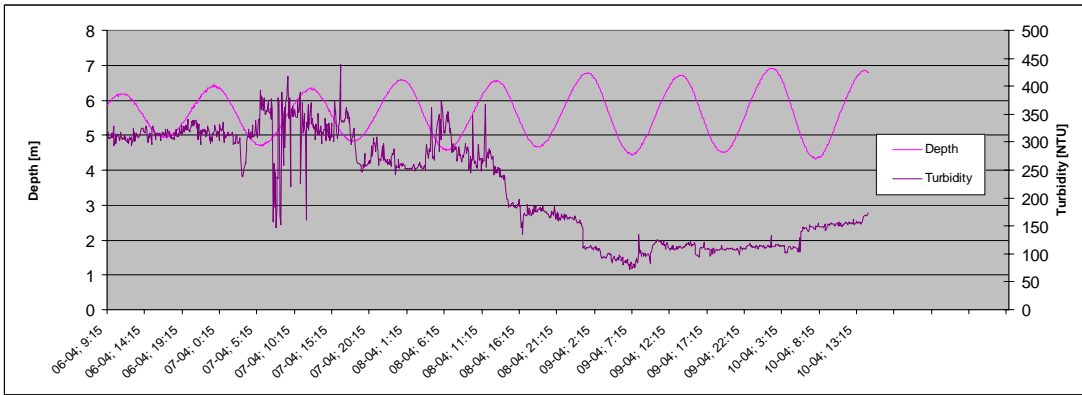

Fig. 36: - Turbidity, Depth; 14th of March to 10th of April

3.3.1.6 Conclusions

A mobile data acquisition system was designed and built using off the shelf equipment. The system was employed during several field campaigns and proved itself as a robust tool for water quality measurements in coastal regions.

User-friendly software was written, to visualize the acquired data as time series and store data to the hard disk of an attached portable computer.

In a second phase, the data acquisition hardware was modified, in order to make real-time measurements with the system deployed on an ocean buoy. Therefore a GSM modem was integrated for data transmission, and an acoustic current meter was added to the sensor package.

A custom made Visual Basic™ code is used to perform the data transfer between the base and the remote station.

The system was tested during several weeks at a pier and proved itself as reliable. The deployment is planned for September 2002 on a navigation buoy, moored at the outer limit of the Tagus estuary.

In the near future, the sensor package shall be extended with a Flourimeter and a Nutrient analyzer. Also a standard meteorological sensor package will be added.

3.3.2 Task 3.2 – Results

The expected results are the process, bank and publish in the WWW of field data and models results. An interface allowing exporting model results in GIS format (ESRI ShapeFile) was already developed with success. This enables us to spread information in more recognizable way via WWW and to interact with data from different sources.

The data banking aspect is still being developed using ASP language and Microsoft Access.

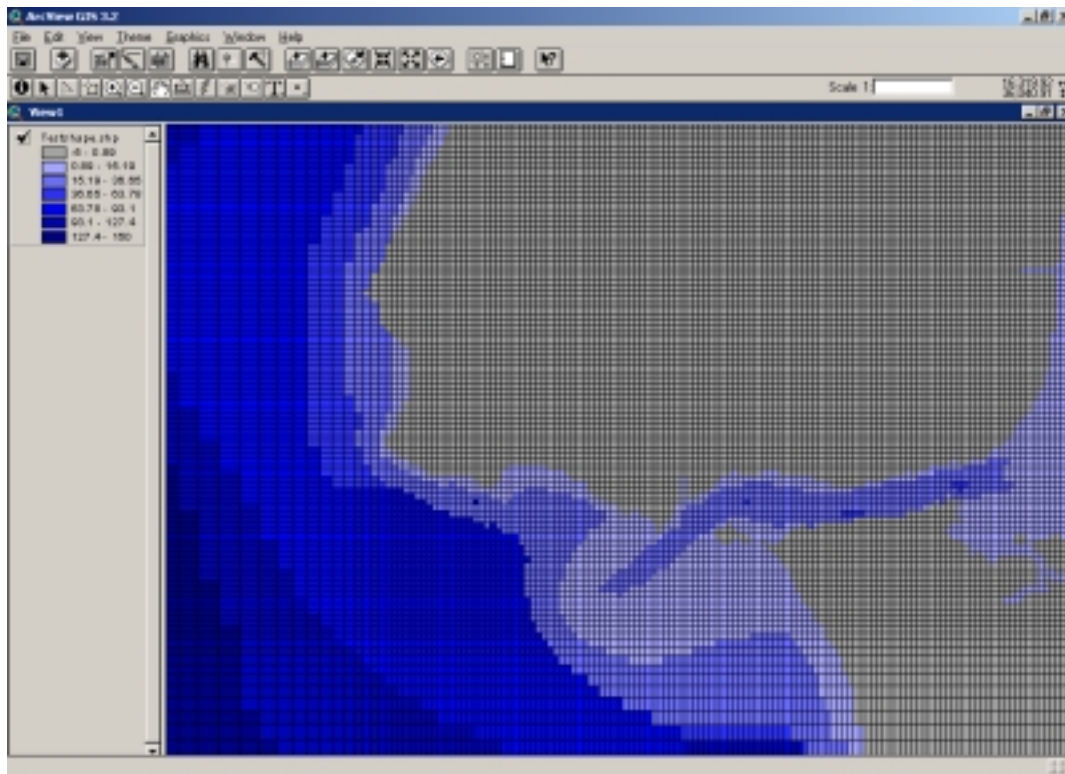

Fig. 37 Model results presented in ArcView 3.2 GIS

3.4 Work Package 4: Integrated operational model

The expected results of this WP are an integrated operational model, a data acquisition system and a database suitable for management of coastal areas applied to Tagus Estuary. The model will assimilate boundary conditions and produce short-term forecasts.

This task is a consequence of the remaining tasks so we can say that all the parts of this integrated operational model are now being assembly and we aspect that at the end of the second year we are able to start testing this product..

4 Summary of the first year of project

The project is “on schedule” considering that it is essential in a first stage to develop and test a robust data acquisition system that already shown good results and in parallel do implement and verify a model to explain the ecological and physical processes occurring in the Tagus estuary. The dissemination of the project expected results is already being made. We have established contacts with several potential users that are

interested in the system namely the company managing the waste water system of the Costa do Estoril and the company managing waste water system of the Lisbon region.